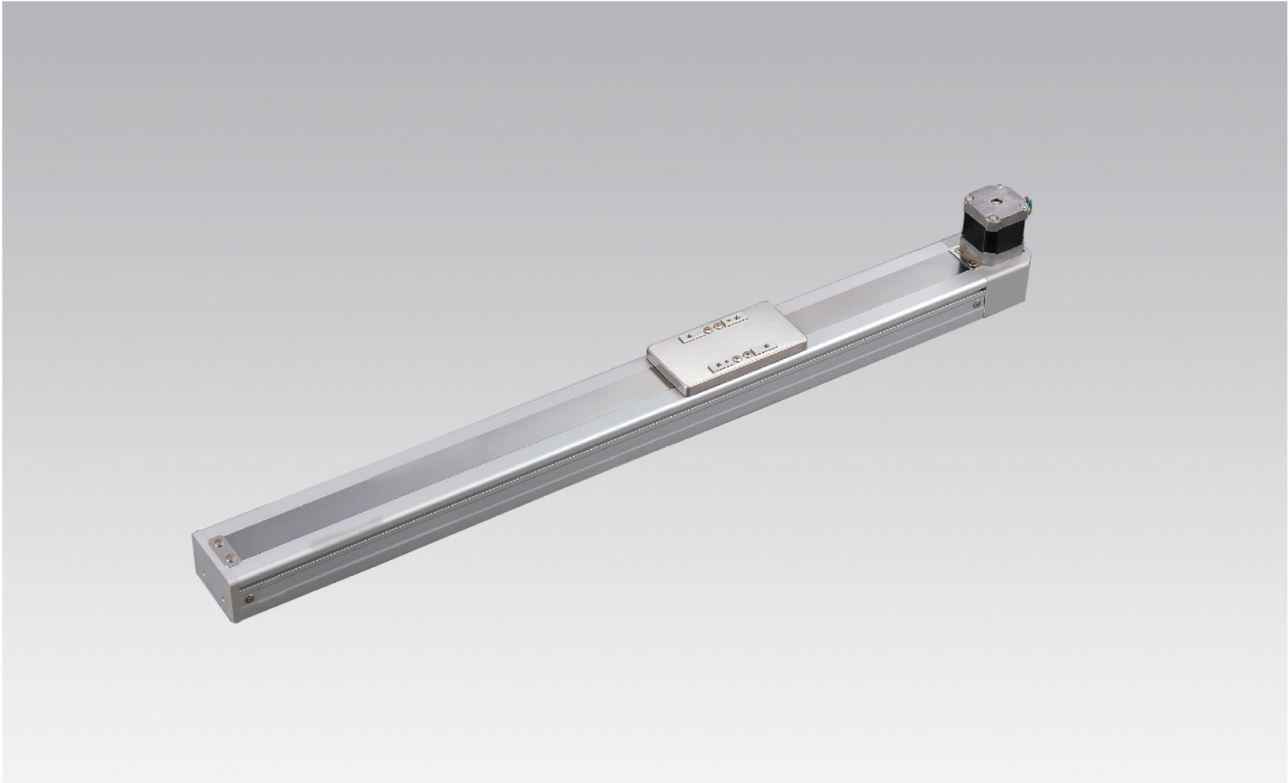

MT60皮帶傳動系列

 最大行程 800 mm
 Maximum Stroke

 最高速度 2000mm/s
 Maximum Speed

 馬達容量 100W
 Motor Output

 皮帶寬度 12mm
 Belt Width

 直線滑軌 42x9.5-1支
 Linear Guide

型號表示方式 Ordering Method

MT50- X 40-200L-BW-M10-C4- M5

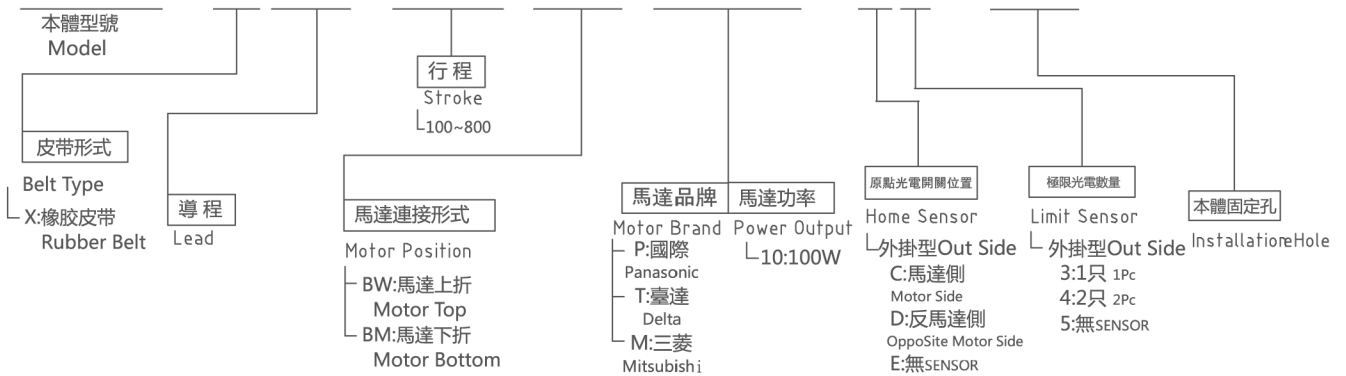

基本仕様 Specification

性能	位置重複精度 Repeatability (mm)	±0.06	
	導程 Lead (mm)	40	
	最高速度 Maximum Speed (mm/s)	2000	
	最大可搬重量 Maximum Payload (kg)	水平使用Horizontal	3
		垂直使用Vertical	
	定格推力 Rated Thrust (N)	42	
	標準行程 Stroke Pitch (mm)	100-800mm/50pitch	
部品	AC伺服馬達容量 AC Servo Motor Output (W)	100W	
	皮帶寬度 Belt Width (mm)	12	
	高剛性直線滑軌High Rigidity Linear Guide (mm)	42X9.5	
	原點感應器 Home Sensor 外掛 Outside	EE-SX672(NPN)	

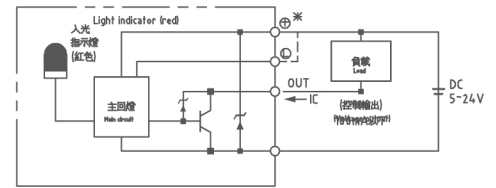
 感應器接線圖 < 原點及端點 >
 Sensor Layout

基本仕様容許負載力距表 N.m Allowable Overhang

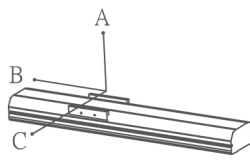

(單位:mm)

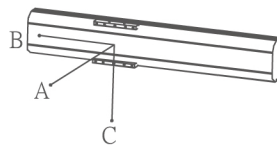

(單位:mm)

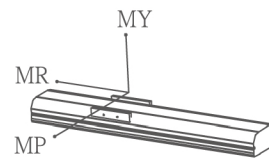
 水平使用時
 Static Loading Moment (單位:N.m)

MY	93
MP	93
MR	257

水平安裝 Horizontal Installation	A	B	C	牆面安裝 Wall Installation	A	B	C
3kg	450	63	200	3kg	150	45	340

搭配伺服馬達一覽表 Suitable Motor Brand

廠牌 Brand	馬達記號 Mark	煞車有無 Brake	馬達容量 Watt W	電源電壓 AC-Voltage AC-V	伺服馬達型號 Motor Model	驅動器型號 Driver Model
三菱 Mitsubishi	M	無煞車(水平仕様) No brake (Horizontal Type)	100	220	HF-KP13	MR-J3-10A
國際 Panasonic	P	無煞車(水平仕様) No brake (Horizontal Type)	100	220	MSMD012P1S	MADDT1205
台達 Delta	T	無煞車(水平仕様) No brake (Horizontal Type)	100	220	ECMA-C20401ES	ASD-B20121-B



BW: 馬達上折

Note1: Position of the table slider when returned to the origin
Note2: Distance from both ends to the mechanical stopper

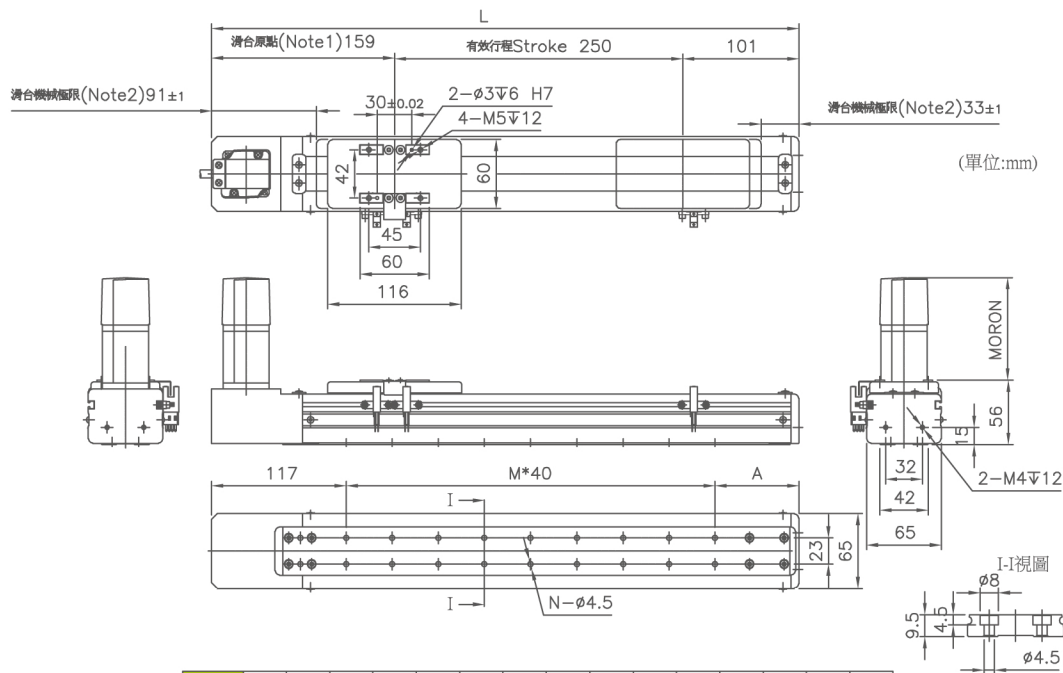

Stroke	100	150	200	250	300	350	400	450	500	550	600	650	700	750	800
L	360	410	460	510	560	610	660	710	760	810	860	910	960	1010	1060
A	83	93	63	73	83	93	63	73	83	93	63	73	83	93	63
M	4	5	7	8	9	10	12	13	14	15	17	18	19	20	22
N	10	12	16	18	20	22	26	28	30	32	36	38	40	42	46
KG	2.5	2.6	2.8	3	3.3	3.4	3.5	3.7	3.9	4.1	4.2	4.4	4.6	4.8	4.9

BM: 馬達下折

Note1: Position of the table slider when returned to the origin
Note2: Distance from both ends to the mechanical stopper

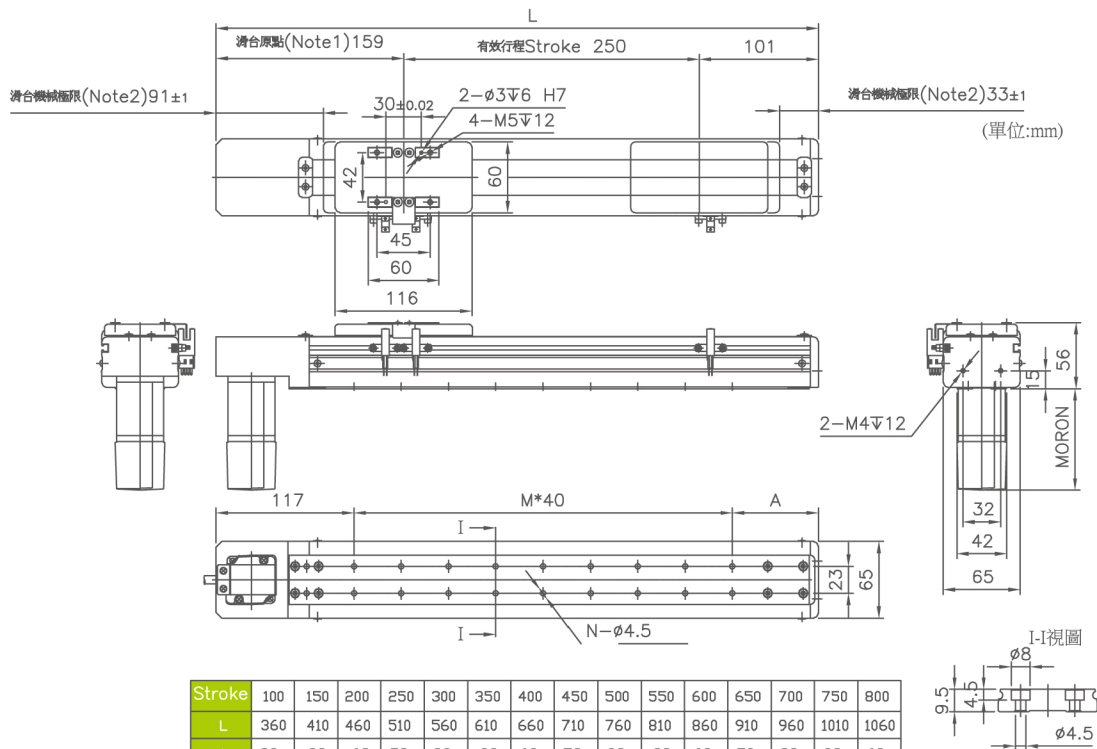

Stroke	100	150	200	250	300	350	400	450	500	550	600	650	700	750	800
L	360	410	460	510	560	610	660	710	760	810	860	910	960	1010	1060
A	83	93	63	73	83	93	63	73	83	93	63	73	83	93	63
M	4	5	7	8	9	10	12	13	14	15	17	18	19	20	22
N	10	12	16	18	20	22	26	28	30	32	36	38	40	42	46

